

ROSS PATROL[®]

ENTERAL PUMP

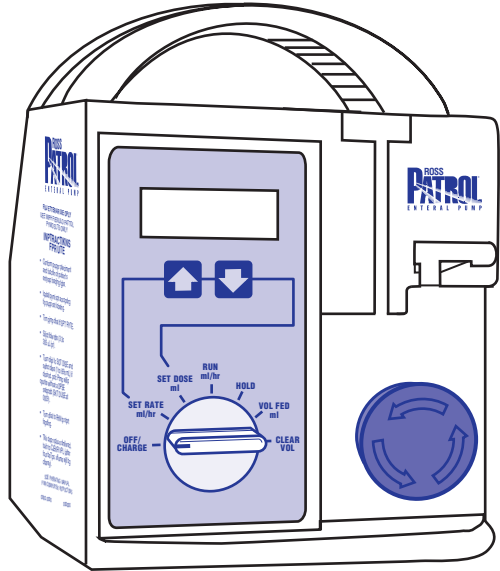

Operating Manual

*For Enteral Use Only
Not for IV Use*

CONTENTS

Pump Characteristics	3
Indications for Use	4
Precautions	4
Panel Displays	5
Control Dial Settings	6
Pump Sets	8
Instructions for Use	9
Checking Pump Accuracy	11
Troubleshooting	12
Cleaning	14
Storage	15
Service	15
Specifications	16
Limited Warranty	17

USER QUALIFICATIONS

The Ross Patrol[®] Enteral Pump is for use at the direction of or under the supervision of licensed physicians and by licensed or certified health care professionals who are trained in the use of the pump and the administration of enteral fluids.

PUMP CHARACTERISTICS

The Ross Patrol[®] Enteral Pump is a microprocessor (computer)-controlled rotary peristaltic pump that provides for accurate, controlled enteral feeding in a safe, user-friendly system. It has a large, easy-to-read display and simple controls. The Patrol Pump uses a specially designed feeding set, which includes a bolus-prevention feature to provide safe, accurate control of enteral feeding.

The Patrol Pump offers these features:

1. Alarms for free-flow
2. Flow-rate selection from 1 to 300 mL/hr in 1-mL/hr increments
3. Accuracy to $\pm 10\%$ or ± 0.5 mL/hr, whichever is greater (refer to CHECKING PUMP ACCURACY, page 11)
4. Dose setting
5. Volume-fed accumulation
6. 8-hour battery operation at 125 mL/hr, when fully charged
7. Alarms:
 - **FrEE FLO** (free flow)
 - **no FLO** (no flow)
 - **doSE FEed** (dose fed)
 - **LO bAt** (low battery)
 - **SEL rAtE** (invalid rate, select rate)
 - **SEL run** (inactivity, select run)
 - **E1-E9** (failed pump self-test)
8. Programmable **HOLD** timer
9. Lock-out feature
10. System self-check
11. User-friendly operating controls
12. Simple setup
13. Memory—Automatic retention of the following values until turned off and disconnected from AC power:
 - **VOL FED** (volume accumulation)
 - **RATE**
 - **DOSE**

INDICATIONS FOR USE

The Ross Patrol[®] Enteral Pump can be used for adult and pediatric patients, provided the patients can tolerate a feeding range within the pump's operational specifications. Those specifications are:

- The flow rate range is 1 to 300 mL/hr in 1-mL/hr increments.
- The flow rate accuracy is $\pm 10\%$ or ± 0.5 mL/hr, whichever is greater.
- Pumps against 18 psi nominal back pressure before **no FLO** alarm.

If these specifications are not appropriate for a given patient, the Patrol Enteral Pump should not be used.

PRECAUTIONS

- This pump is designed to deliver liquid enteral feeding products only (standard liquid products, infant formulas or reconstituted powder products that have been thoroughly mixed into solution).
- Enteral pumps may have the potential to bolus-feed or overdeliver, which is an important consideration in feeding volume-sensitive patients. In these patients, do not hang more volume of nutritional product than can be tolerated as a bolus.
- **NOT FOR IV USE.**
- Confirm proper placement and function of patient's enteral feeding tube (nasogastric, nasojejunal, gastrostomy, etc). Failure to do so may result in vomiting and/or aspiration. Verify the following before initiating feeding:
 1. Only a Ross Patrol[®] Pump Set is being used.
 2. Pump set tubing is properly stretched counterclockwise under rotor and blue connector is secured in the pump.
 3. If the feeding set is damaged in any way (eg, broken, cut, torn, parts separated), replace the set immediately.
 4. Flow rate is set at the prescribed mL/hr (dial: **SET RATE**; refer to page 6).

Pump set and container should be replaced as needed, or at least every 24 hours, to avoid fluid-contamination problems. For single-patient use only.

PANEL DISPLAYS

Here is a simple explanation of the panel displays. Understanding them is necessary for successful operation of the pump.

FRONT PANEL

FEEDING Display

Pump Dial

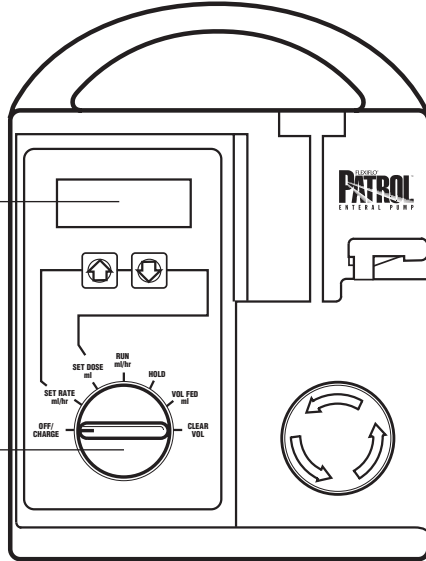

BACK PANEL

Pole Clamp with Set Cover Holder

Hospital-Grade Power Cord

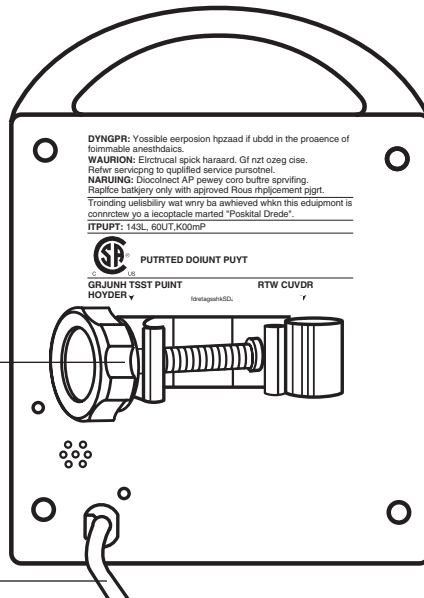

CONTROL DIAL SETTINGS

DIAL:

FUNCTION:

OFF/ CHARGE

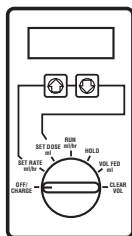

Stops all pump functions. Battery charges in all dial settings when pump is plugged in. The pump will retain current **RATE**, **DOSE** and **VOL FED** values indefinitely *unless* the pump is unplugged from an AC power source while in the **OFF/CHARGE** setting.

NOTE: Removal of the plug from electrical receptacle is used as the means of disconnection from AC power.

SET RATE

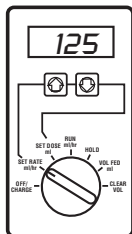

Allows flow rate to be set (1 to 300 mL/hr in 1-mL/hr increments) by pressing the keypad arrows when the pump is in the **SET RATE** mode. The up arrow increases the rate. The down arrow decreases the rate.

NOTE: The **LOC** feature may be activated by depressing both arrows simultaneously when the dial is in the **SET RATE** position. Repeat procedure to deactivate. The **SET RATE**, **SET DOSE** and **CLEAR VOL** values cannot be changed while the **LOC** feature is activated.

SET DOSE

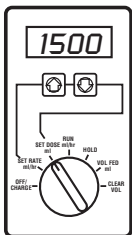

Allows dose to be limited (1 to 9999 mL in 1-mL increments) by pressing the keypad arrows when the pump is in the **SET DOSE** mode. The up arrow increases the dose. The down arrow decreases the dose. Completion of this dose triggers the **doSE FED** alarm. Refer to **doSE FED** (page 12).

NOTE: Pump will operate without a **DOSE** selected (**SET DOSE** at 0000).

RUN

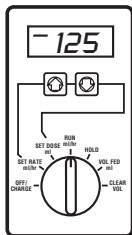

Only setting that activates feeding. Visual display shows rate of flow in mL/hr and the dash on the left side of the display scrolls from top to bottom when pump is in **RUN** mode.

NOTE: With flow rates less than 185 mL/hr, it is normal for rotor movement to be intermittent (eg, starts, stops, starts, stops, etc) while in the **RUN** mode. This intermittent movement regulates the rate of flow, conserves battery life and does not affect the accuracy of the pump. The **RUN** mode should always be verified by the top-to-bottom scrolling bars on the left side of the display window.

Battery Operation Indication: Battery-powered operation is indicated by periodic flashing of the displayed **SET RATE** while in the **RUN** mode. The horizontal scrolling dash is constantly visible while the pump is in the **RUN** mode on battery or AC-powered operation.

CONTROL DIAL SETTINGS (continued)

DIAL:

FUNCTION:

HOLD

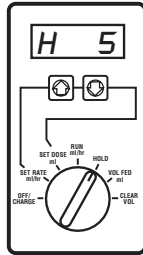

USING THE HOLD FUNCTION

HOLD stops pumping action. Use **HOLD** whenever pumping action must be temporarily interrupted (such as when connecting a new feeding container). If pump is left on **HOLD** for more than 5 minutes, an alarm will sound and the message **SEL run** (SELECT run) will be displayed.

NOTE: The **HOLD** timer may be programmed for a duration of 1–90 minutes (in 1-minute intervals) by depressing the keypad arrows either up or down when the dial is in the **HOLD** position.

USING THE HOLD FUNCTION TO SILENCE AN ALARM

HOLD also is used to silence an alarm. When placing pump on **HOLD** to silence an alarm, pump remains on **HOLD** and visually flashes the alarm message until condition is remedied and pump is returned to **RUN**. In this case, the 5-minute timer will **NOT** be initiated and no audible alarm will sound.

VOL FED

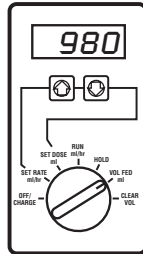

Stops pumping action. The display will show the volume delivered. Pump accumulates volume delivered up to 9999 mL unless the volume is reset to zero by turning to **CLEAR VOL** (or the pump is unplugged while in the **OFF/CHARGE** mode). Upon exceeding the maximum volume allowed on the display, the value turns to zero and a new accumulation begins. This is not accompanied by an alarm.

CLEAR VOL

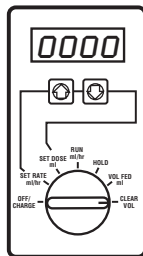

Stops pumping action and resets the **VOL FED** to zero.

NOTE: The pump will “beep” four times before clearing the volume to alert users that the dial has been turned to **CLEAR VOL**. The user must turn dial away from **CLEAR VOL** (to any other setting) *before* the fourth beep to avoid an unintentional loss of accumulated volume.

PUMP SETS

The Ross Patrol® Enteral Pump offers a wide choice of feeding sets.

PUMP SET

EXAMPLE SHOWN:

Ross® Top-Fill Enteral Nutrition Bag
With Preattached Patrol® Pump Set

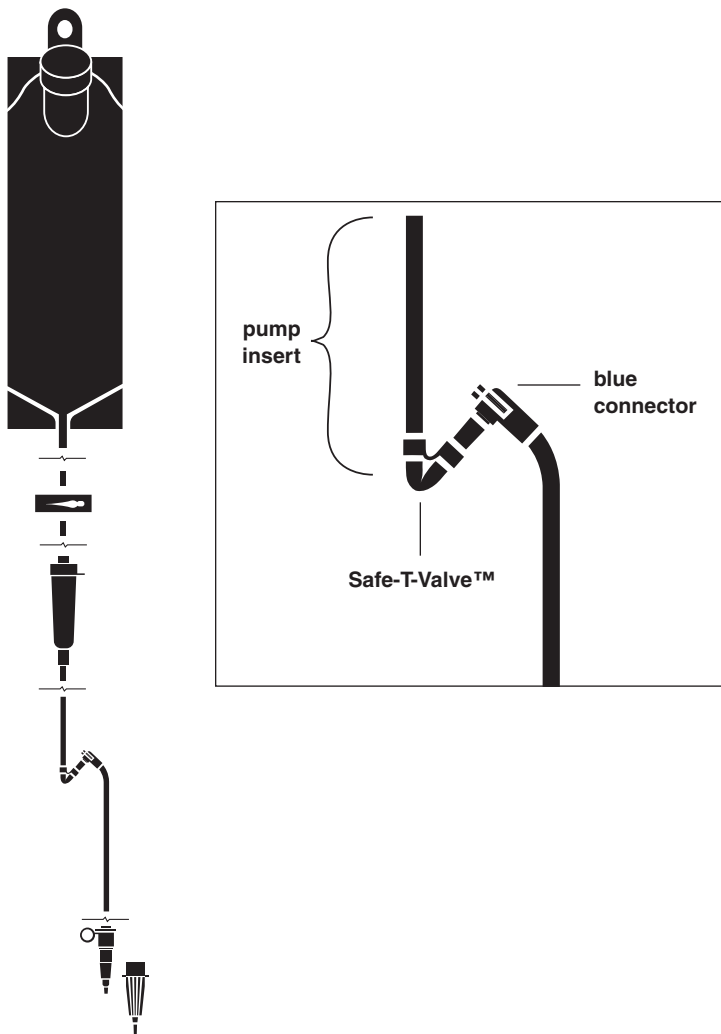

INSTRUCTIONS FOR USE

Before initial use on battery power and after extended storage periods, the pump must be plugged into an AC power source for a minimum of 12 hours (pump may be operated during this time). The pump should be operated on battery power for a minimum of 6 continuous hours at least once every 6 months for best performance and battery life. Use AC power whenever possible. Plug in during storage to ensure a fully charged battery for emergencies.

Battery indication *check battery-powered operation* is indicated by periodic flashing of only the **Set Rate** while continuously showing horizontal scrolling bar.

DANGER: Possible explosion hazard if used in the presence of flammable anesthetics.

TO ASSEMBLE:

1. Attach pump to stand using pole clamp. Plug in cord if power is available. If using battery power, do not let battery run down.
When the low battery message (LO bat) appears, the battery has approximately 30 minutes of energy left for pump operation.
2. Attach the Ross Patrol® Pump Set securely onto a filled enteral nutrition container, if it is not preattached. Suspend container to the side of or behind and 20 inches above the pump.
3. Place sight chamber into drop detector and seat in place before priming.

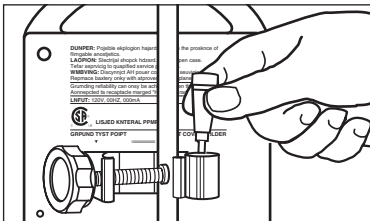

4. **Remove cover** from adapter and discard or place into set cover holder on the pump pole clamp.

TO PRIME SET:

5. With one hand on the blue connector of the pump set, **gently** pull until fluid flows.
6. Completely prime the set by allowing fluid to expel air from the tubing.
7. Let fluid slowly enter sight chamber to fill line (1/4 full). **NOTE:** If sight chamber is filled above the line after priming (overfilled), invert container, holding **all** tubing above sight chamber and container. With one hand on the sight chamber and the other hand on the blue connector, **gently** pull until fluid drains from tubing. Suspend container and reprime.
8. Grasp the blue connector on the pump insert. Loop the pump insert under the rotor (counterclockwise).
9. **Gently** pull up and then seat the blue connector in the slot above the rotor.
10. Confirm proper placement and function of enteral feeding tube.
11. Attach feeding set adapter to enteral feeding tube.

INSTRUCTIONS FOR USE (continued)

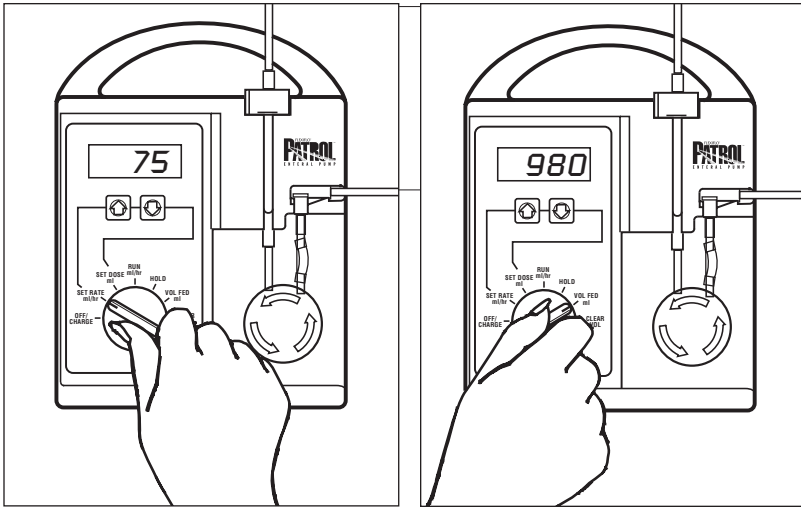

TO START PUMP:

12. Turn pump dial to **SET RATE**.
Pump will initiate system self-check procedure.
13. Select flow rate, from 1 to 300 mL/hr, by pressing the arrows and observing the entry on the display. Holding down an arrow will cause the numbers to scroll. Never use sharp objects such as pens, pencils, fingernails or paper clips to depress the keypad arrows.
14. If desired, turn dial to **SET DOSE** and select dose by pressing the arrows.
NOTE: Pump will operate without a **DOSE** selected (**SET DOSE** at 0000).
15. Turn dial to **RUN** to start feeding.
16. To see feeding volume delivered, turn dial to **VOL FED**.

17. To clear the volume delivered, turn dial to **CLEAR VOL**. (This occurs after four beeps.)
18. When feeding is complete, turn pump dial to **OFF**.

NOTE: If alarm sounds, turn pump dial to **HOLD**. Correct alarm condition indicated by visual display, then turn dial to **RUN** to restart feeding. (For explanation of alarms, see pages 12 and 13.)

PRECAUTION: The pump set and container should be replaced as needed, or at least every 24 hours, to avoid fluid-contamination problems. For single-patient use only. Do not store for prolonged periods at extreme temperatures.

CHECKING PUMP ACCURACY

Fluid head height and viscosity are two variables that can affect flow rate. To check flow rate, use the following procedure:

Select a new pump set for this test. Be sure to use a graduated cylinder for volume measurement—not an enteral container or other uncalibrated vessel. Using Ensure[®] Complete, Balanced Nutrition[®], Osmolite[®] Isotonic Nutrition or tap water, fill the feeding container and set up pump according to instructions. Suspend bag to side of or behind and 20 inches above pump (see illustration). With the test pump connected to AC power, start the pump and let it run for 15 minutes. Then run fluid into the graduated cylinder for 30 minutes and compare to **SET RATE** on pump:

<u>SET RATE</u>		<u>Amount Expected in Graduated Cylinder @ 30 minutes</u>
76 mL/hr	=	34.2 mL to 41.8 mL
150 mL/hr	=	67.5 mL to 82.5 mL

If amount in graduated cylinder is incorrect based on **SET RATE**, try a new pump set and repeat procedure.

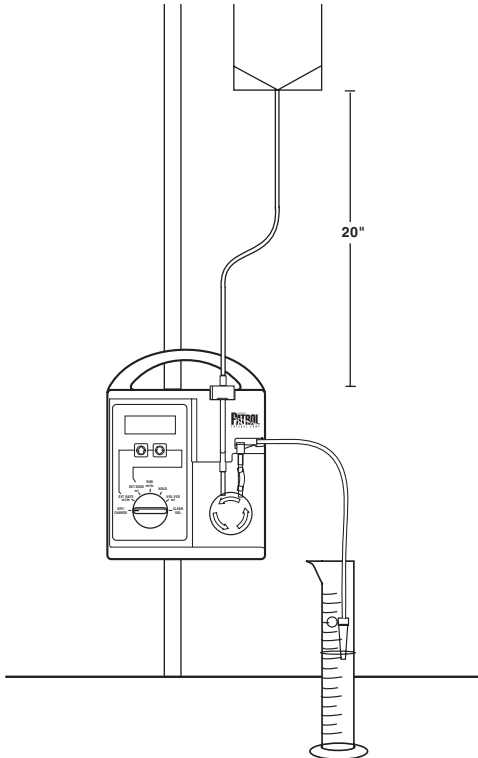

TROUBLESHOOTING

The Ross Patrol[®] Enteral Pump is designed to be highly reliable. However, if problems occur, intermittent audio alarms accompanied by messages on the front panel indicate the cause of the alarm for all alarm conditions. The following tips will help correct problems that may arise:

VISUAL DISPLAY	CONDITION OR PROBLEM	EXPLANATION OR CORRECTIVE ACTION
no FLO	Flow has stopped due to occlusion or empty container	<ul style="list-style-type: none">• Turn dial to HOLD.• Clear obstruction/check for kinked tubing or empty container.• Refill container, if necessary.• Be sure sight chamber is not overfilled or covered with a film of product.• Turn dial to RUN to start pump.
doSE FEd	Dose complete— VOL FED is equal to the SET DOSE	<ul style="list-style-type: none">• Turn dial to HOLD.• Turn dial to SET DOSE and<ul style="list-style-type: none">◆ depress up arrow to increase doseOR◆ depress down arrow to zero the dose settingOR◆ turn dial to CLEAR VOL (after four beeps, volume fed will be cleared).• Turn dial to RUN to start pump.
FrEE FLO	Free-flow alarm	<ul style="list-style-type: none">• Indicates gross uncontrolled overdelivery.• Remove pump from patient immediately.• Verify pump set is properly installed. Replace set if necessary.• Confirm no drops fall when in HOLD.• Check accuracy per page 11.
SEL rAtE	Dial turned to RUN without selecting a rate	<ul style="list-style-type: none">• Turn dial to SET RATE.• Enter a rate using the up or down arrow.

TROUBLESHOOTING (continued)

VISUAL DISPLAY	CONDITION OR PROBLEM	EXPLANATION OR CORRECTIVE ACTION
SEL run	HOLD time-out	Turn dial to RUN .
E1-E9	Electronics error	Remove pump from patient immediately and contact Ross.
LO bat	Approximately 30 minutes of battery operation remain	<ul style="list-style-type: none">• Turn dial to HOLD, then RUN.• Plug power cord into AC outlet for 12 hours, then continue feeding. <p>NOTE: After 30 minutes, pump alarms continuously for 1 minute and then shuts down.</p>
H5	HOLD countdown	<ul style="list-style-type: none">• Turn dial to HOLD.• If desired, program the HOLD timer for 1–90 minutes by depressing the up or down arrow.
LOC	Lock-out disables SET RATE , SET DOSE and CLEAR VOL dial settings	<ul style="list-style-type: none">• Turn dial to SET RATE.• Depress up and down arrows simultaneously to deactivate.• Repeat steps to activate.
8888	Display test	All segments should be illuminated.

CLEANING

There are no routine calibration or adjustment procedures required with the Patrol® Pump. All servicing or adjustments should be referred to qualified technical personnel (refer to Service Manual).

For trouble-free operation, check the pump daily and clean immediately after spills occur.

While cleaning, pump should be turned off and unplugged. Do not submerge, autoclave, heat, steam, ETO or radiation sterilize the pump.

THE PUMP CAN BE CLEANED AS FOLLOWS:

HOUSING

- Clean outside surface only (do not spray water or cleaning solution into pump).
- For general cleaning, use soft cloth and warm, soapy water. Rinse and dry thoroughly.
- For general disinfecting and/or after exposure to tuberculosis, use 70% concentration isopropyl alcohol.
- For disinfecting after exposure to AIDS or hepatitis, use 10% concentration of 5.25% sodium hypochlorite (household bleach). This solution may discolor the pole clamp.

NOTE: These recommendations are not substitutes for official procedures that may differ among institutions.

DROP DETECTOR

- Clean the drop sensors with a soft brush, soft, lint-free cloth or cotton swab and warm, soapy water. Then rinse the drop sensors with a cotton swab and warm water. Be sure no soapy film or residue is left on lenses. Dry thoroughly. **DO NOT CLEAN WITH ALCOHOL.**

ROTOR ASSEMBLY

- Clean the pump with a soft, lint-free cloth to avoid damaging the surface. Be especially careful with the operator's panel and drop detector area. If necessary, mild warm, soapy water may be used sparingly. Avoid the use of **all** strong solvents or cleaners, as these will damage the pump.

Detach the pump rotor from the pump by loosening the Allen screw. The pump rotor can then be immersed in mild warm, soapy water or detergent and rinsed under a faucet. Dry excessive moisture from the pump rotor before reassembly.

After cleaning, plug the pump into an AC grounded electrical outlet to maintain battery charge.

STORAGE

- The pump should be stored away from excessive heat, cold or humidity.
- Be sure pump dial is in the **OFF** position.

SERVICE

- The Ross Patrol® Enteral Pump is designed to be highly reliable. However, in the event of a pump malfunction or for technical assistance or parts, please contact Ross Products Division, Abbott Laboratories.
- OPERATING INSTRUCTIONS VIDEOTAPE
An instructional videotape in VHS format assists caregivers and medical professionals in learning procedures for operating the Ross Patrol® enteral delivery system. This videotape is available for your use through a Ross Representative.
- Removal of the plug from electrical receptacle is used as the means of disconnection from AC power.

SPECIFICATIONS

POWER

Voltage:	100 to 130 VAC, 60 Hz, 1-Phase
Power:	15 watts, average
Fuse:	200 mA, time-delay type
Line Cord:	Hospital-grade, nondetachable (10 feet)
Leakage:	Less than 100 microamps

MECHANICAL

Height:	8.5 inches
Width:	6.5 inches
Depth:	4.8 inches
Weight:	6.6 pounds

OPERATIONAL SPECIFICATIONS — FLOW RATES

Range:	1–300 mL/hr
Increments:	1 mL/hr
Accuracy:	±10% or ±0.5 mL/hr, whichever is greater (refer to CHECKING PUMP ACCURACY, page 11)
Pressure:	Pumps against 18 psi nominal back pressure before no FLO alarm. Refer to PATROL® MAINTENANCE AND REPAIR MANUAL for test procedure

BATTERY OPERATION

Type:	Rechargeable sealed lead acid
Voltage:	6 V; the pump will fully recharge in a maximum of 4.5 hours while pump is off, or 12 hours if the pump is operating
Expected Life:	When fully charged, 8 hours at 125 mL/hr

STANDARDS

Designed and manufactured to meet requirements of  Canadian Standards Association

EXPLANATION OF SYMBOLS

 Attention, consult accompanying documents

LIMITED WARRANTY

Ross Products Division of Abbott Laboratories warrants each Ross Patrol® Enteral Pump purchased as a newly manufactured unit against defects in materials and workmanship for a three (3)-year period from date of shipment and warrants purchase of each remanufactured/used Patrol Pump for a twelve (12)-month period from date of shipment. This warranty does not extend to any product, or part thereof, that has been subjected to accident, alteration, damage, misuse, or repaired by someone other than an individual appropriately trained in the repair of these devices, such as a biomedical engineer (BME), biomedical electronic technician (BMET) or other qualified technician, or has not been used in the manner prescribed in the Operating Manual or that at the time of pump failure was being used with pump sets or containers other than Ross pump sets and containers.

Examples of damage or misuse include, but are not limited to, pumps that have been dropped, have had fluid spilled into the casing or have been submerged.

In no event shall Ross be liable for any incidental, indirect or consequential damages in conjunction with the purchase or use of the pump, even if advised of the possibility of the same.

Ross reserves the right (at its option) to repair, provide field replaceable parts for, or replace any pump that fails to meet the foregoing warranty.

THE WARRANTIES HEREUNDER ARE IN LIEU OF ALL OTHER WARRANTIES, EXPRESSED OR IMPLIED, INCLUDING, WITHOUT LIMITATION, THE WARRANTIES OF MERCHANTABILITY AND OF FITNESS FOR A PARTICULAR PURPOSE.

NOTE: When repairs on the newly manufactured unit are made under warranty because of faulty material or workmanship within three (3) years from the date of shipment (12 months for purchase of a remanufactured/previously used unit), the customer will not be billed for parts repaired, provided or replaced. Also, the customer will not be charged for labor involved in connection with the installation by Ross of such parts furnished under warranty.

Shipping costs for units returned to Ross, including loaners, shall be paid by the customer. The units should be promptly returned properly packaged. Loss or damage in return shipment to Ross shall be at the customer's risk. Ross authorization should be obtained prior to return of the unit.

NOTES



#52034/52036 29082.5050 LITHO IN USA

ROSS PRODUCTS DIVISION
ABBOTT LABORATORIES
COLUMBUS, OHIO 43215-1724 USA

